



SYSTEMS ENGINEERING VISION 2020

Document No.: **INCOSE-TP-2004-004-02**
Version/Revision: **2.03**
Date: September 2007

Released by:

Technical Operations

International Council on Systems Engineering (INCOSE)

Copyright Notice

This INCOSE Technical Product was prepared by the Systems Engineering Vision Working Group of the International Council on Systems Engineering (INCOSE). It is approved by the INCOSE Technical Operations for release as an INCOSE Technical Product.

Copyright (c) 2007 by INCOSE, subject to the following restrictions:

Author use: Authors have full rights to use their contributions in a totally unfettered way with credit to the INCOSE Technical Product.

INCOSE use: Permission to reproduce this document and to prepare derivative works from this document for INCOSE use is granted provided this copyright notice is included with all reproductions and derivative works.

External Use. This document may be shared or distributed to non-INCOSE third parties. Requests for permission to reproduce this document in whole are granted provided it is not altered in any way. Extracts for use in other works are permitted provided this copyright notice and INCOSE attribution is included with all reproductions. Requests for permission to prepare derivative works of this document for commercial use will be denied unless covered by other formal agreements with INCOSE Central Office, 7670 Opportunity Rd., Suite 220, San Diego, CA 92111-2222, USA.

Service marks. The following service marks and registered marks are used in this document:

Capability Maturity Model IntegrationSM (CMMISM) – Software Engineering Institute
Systems Modeling LanguageTM (SysMLTM) – Object Management Group

Permissions: INCOSE has granted permission to member companies of the INCOSE Corporate Advisory Board to post and use this document internally, subject to the INCOSE use restriction.

Feedback

Any type of comment is appreciated. Feedback and requests shall be addressed to vision@incose.org.

Table of Contents

Executive Summary	5
Introduction	7
Purpose and Scope	7
Vision 2020 Integrating Framework	7
Current State and Trends.....	9
Global Systems Engineering Environment	9
Systems and their Nature.....	11
Systems Engineering Processes.....	14
Models and Model-based Systems Engineering.....	15
Systems Engineering Education.....	16
Drivers and Inhibitors.....	19
Systems Engineering Vision 2020	20
Global Systems Engineering Environment	20
Systems and their Nature.....	21
Systems Engineering Processes.....	22
Model-Based Systems Engineering.....	23
Systems Engineering Education.....	25
Implications for the Advancement of Systems Engineering	28
Systems and their Nature.....	28
Systems Engineering Processes.....	28
Model-Based Systems Engineering.....	29
Acknowledgements	31

Table of Figures and Tables

Figure 1 – An integrating framework for the Systems Engineering Vision 2020	7
Figure 2 – Costs committed during preliminary conception of product development	8
Figure 3 – Capabilities of integrated enterprise environments	9
Figure 4 – Accelerating pace of technology innovation.....	12
Figure 5 – Transition from document-centric to model-centric systems engineering.....	14
Figure 6 – Engineering Competence Profiles.....	16
Figure 7 – Harmonization of Systems and Software Engineering Standards.....	19
Figure 8 – Cross-domain model integration.....	22
Figure 9 – Conference on Systems Engineering Research.....	24
Table 1 - Attributes of systems used to observe changes over time.....	9
Table 2 – Drivers and inhibitors influencing the practice of systems engineering.....	17
Table 3 - Systems Engineering Vision 2020 Focus Groups.....	27

Executive Summary

Systems Engineering Vision 2020 projects the state of practice for the field of systems engineering to the year 2020. This document is intended to be the authoritative source of a shared vision for the global systems engineering community and interested stakeholders. It contains both information and insights with regard to the anticipated evolution of systems engineering practice and the benefits of a disciplined, systems approach to address complex problems.

This vision of the evolution of systems engineering begins with an assessment of the current state of practice and trends, identifies drivers and inhibitors, then extrapolates the future state of practice in systems engineering. This analysis is conducted in five focus areas - the Global Systems Engineering Environment, Systems and their Nature, Systems Engineering Processes, Models and Model-Based Systems Engineering, and Systems Engineering Education. A closing section on the Implications for the Advancement of Systems Engineering suggests meaningful areas of research investment for internationally advancing the discipline and practice of systems engineering based on this analysis.

Several significant trends in the global environment are leading to the emergence of a more widespread and effective application of the systems engineering practice. There is a growing realization that systems engineering is essential to successfully design, develop and sustain the highly complex systems of the 21st century. Yet, the profession suffers from the lack of a set of unified principles, models that support a wide range of domains, and consistent terminology and definitions. Furthermore, there is a prevailing perception that systems engineering is overly cumbersome and not readily applicable to small projects or small businesses.

One can expect a shift away from a “one size fits all” definition and application of systems engineering to a more specifically defined and precise application of systems engineering in diverse domains. The future systems engineering environment will fully support life cycle perspectives such as supply chains and system sustainment. New cost models will begin to quantify the bottom-line contributions of systems engineering practices.

Technology innovations are the primary drivers that influence the capabilities of system products, as well as the practice of systems engineering. Chief among these is the continuing evolution of information technology, with associated applications to both system implementations (both large and small, including micro-systems) and to model-based techniques for systems engineering. Emerging conceptual and technological areas, such as complexity theory, nano-technology and genetic engineering already stretch the validity of present systems engineering processes.

In many respects, the future of systems engineering can be said to be “model-based.” A key driver will be the continued evolution of complex, intelligent, global systems that exceed the ability of the humans who design them to comprehend and control all aspects of the systems they are creating. The role of modeling will mature to respond to this need. Virtual development environments will minimize the need for physical prototypes and accelerate the development time for new products while providing realistic verification against customer requirements. These environments will support a seamless flow of product information across all phases of the system life cycle, including design, engineering, implementation, test and evaluation, and operational support. Workflow management tools will support the globally distributed, collaborative teams that will utilize these virtual development environments. Management of product data throughout the lifecycle will be enhanced by

improved support in the logistics and operations and maintenance phases using design data retained in common repositories governed by data exchange standards.

The number of masters' programs in systems engineering is growing faster than bachelors and PhD programs. An infusion of systems thinking and limited exposure to systems engineering principles is beginning to appear in undergraduate engineering curricula. There is a trend toward increased use of scenario-based education and team projects that provide the opportunity to apply systems engineering to a real-world problem. However, most traditional engineering programs do not provide a systems engineering focus. As a result, many companies have no alternative but to hire engineers with a narrow skill-set and offer on-the-job training in systems engineering. In the US in particular, this has led to the rise of systems engineering certification programs.

Use of technologies such as simulation, visualization, and gaming will lead to innovations in systems engineering education. New institutional forms and frameworks will involve humans, organizations, technologies and environments appropriate for the resolution of contemporary issues of large scale and scope. The projected systems engineering state of practice also has important implications for systems engineering research.

It is important to acknowledge that steps taken by professional organizations related to systems engineering will also influence the future state of practice through the strategies they implement, especially those strategies that enable the evolution of systems engineering standards, education and certification, and research. In this regard, it is anticipated that this version of the Systems Engineering Vision 2020 document will provide the basis for identifying "actionable areas" for cooperative activities across the systems engineering community. These might include, for example, jointly sponsored activities related to process improvement, education, and research initiatives. These activities could take the form of symposia, workshops, and projects. Other possibilities might include strategies for the application of systems engineering to help resolve natural disasters as well as global social, economic, and ecological problems. These could be the basis for interactions with government agencies and other international organizations.

This version of the Systems Engineering Vision 2020 is released September 2007.

Approved:

Harry E. Crisp, Jr

INCOSE Systems Engineering Vision 2020 Project Lead

Richard Wray, Co-Chair for Products Development

Chair, INCOSE, Technical Review Team

Chair, INCOSE Technical Leadership Team

Introduction

Purpose and Scope

Systems Engineering Vision 2020 forecasts the state of practice for the field of systems engineering to the year 2020. This document is intended to be the authoritative source of a shared vision for the global systems engineering community, and interested stakeholders. It has been written particularly to support the collaboration of the visionary leaders and pioneers in industry, academia, and government as they work together toward a harmonious convergence of this vision and strategies for its realization.

Annexes to the *INCOSE Systems Engineering Vision 2020* are provided in a separate document, including the January 2006 Systems Engineering Vision 2020 Workshop focus group reports; appendices based on the January 2004 Systems Engineering Technical Vision Workshop; the April 2006 Systems Engineering Research Vision Workshop results; and the July 2006 Modeling and Simulation Vision Workshop results. The ideas put forward in this document are drawn largely from these workshop documents.

Additional sources of content have been derived from the review and recommendations of the following organizations: the UK Institution of Engineering and Technology, the Systems Engineering Society of Australia, l'Association Francaise d'Ingenierie Systeme, the American Institute of Aeronautics and Astronautics, the International Society of Logistics, and the European Society for Collaborative Engineering.

Vision 2020 Integrating Framework

As illustrated in Figure 1 below, the *INCOSE Systems Engineering Vision 2020* forecasts the future state of the practice of systems engineering, extrapolated from evolutionary developments in the current state of practice and trends, and a set of drivers and inhibitors that will influence the future state. The analysis is conducted in five focus areas, as follows:

- Global Systems Engineering Environment sets the international context and imperatives;
- Systems and their Nature describes the scope and technical areas of the discipline;
- Systems Engineering Processes defines elements of the practice of the discipline;
- Models and Model-based Systems Engineering introduces new capability into systems engineering practices; and,
- Systems Engineering Education provides an insight into the primary source of communicating and advancing the principles and practice.

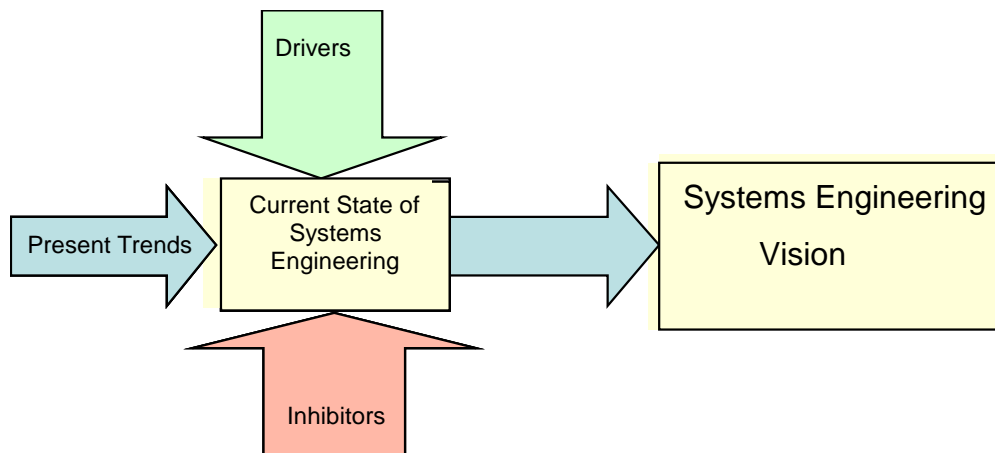

Figure 1 – An integrating framework for the Systems Engineering Vision 2020

This document discusses each element of the framework beginning with the current state and trends in each of the five focus areas. Overarching factors that drive or inhibit changes to the present state of systems engineering are identified, followed by a projection for the future state of systems engineering practice presented as *Vision 2020*. A section on Implications for the Advancement of Systems Engineering provides some suggested research initiatives. The document closes with a summary, acknowledgements and list of references.

Current State and Trends

The current state of systems engineering practice is analyzed in this section using five broad categories; Global Systems Engineering Environment, Systems and their Nature, Systems Engineering Processes, Model-Based Systems Engineering, and Systems Engineering Education.

Global Systems Engineering Environment

The first focus area examines the global environment in which systems engineering exists and is practiced. The current state of systems engineering practice is the product of changes that have taken place over the past 25 years, beginning with concurrent engineering practices introduced in the early 1980s. The tendency towards sequential and separate discipline practices of the past have been replaced by integrated product and process development where developers consider all life-cycle elements at the earliest stages. As indicated by Figure 2, a significant motivation for this trend is the potential to reduce risks and control costs beginning in the earliest stages of product development.

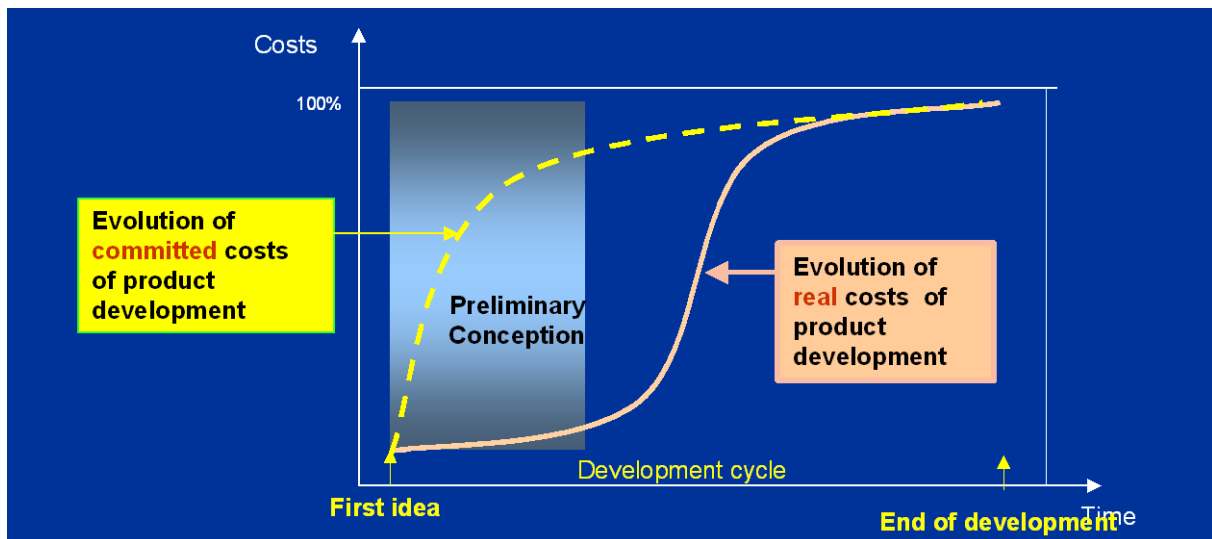

Figure 2 – Costs committed during preliminary conception of product development

Presently, there are significant trends in the global environment leading to the emergence of a widespread and effective state of the systems engineering practice. At the same time, the current global environment also contains negative factors--counter-trends--that inhibit greater application and better results from systems engineering.

On the positive side, major commercial and government organizations have recognized the importance and value of systems engineering. With this comes greater recognition of the importance of style, culture and social issues in the systems engineering environment, plus increasing understanding of the need to improve systems engineering practices. Furthermore, there is an emerging desire for improved collaboration between systems engineering professional organizations and other societies.

International collaboration is visible in the areas of standards and identifying and measuring the maturity of systems engineering processes. In the area of standards, the US Department

of Defense continues to focus on the use of commercially available standards. This has resulted in the publishing of EIA 632 and IEEE 1220 as US standards in 1998. These are now being updated and aligned with the international standard, ISO/IEC 15288. The focus on measuring systems engineering process maturity has culminated in a joint effort between INCOSE, the National Defense Industrial Association (NDIA), and the Software Engineering Institute (SEI) to generate an integrated capability maturity model, or CMMI^{SM1} for both systems engineering and software. Using widely recognized processes and best practices that contribute to successful products, the CMMISM supports assessment of various levels of maturity in implementing these practices within an organization. CMMISM has been adopted by many companies worldwide.

Geographically distributed, multi-disciplinary teams working in collaborative environments are becoming the norm. Corporate enterprise environments, as illustrated by Figure 3, have evolved to support these teams. These environments provide a common operating environment that supports user access to a broad range of engineering, modeling, simulation, and business tools.

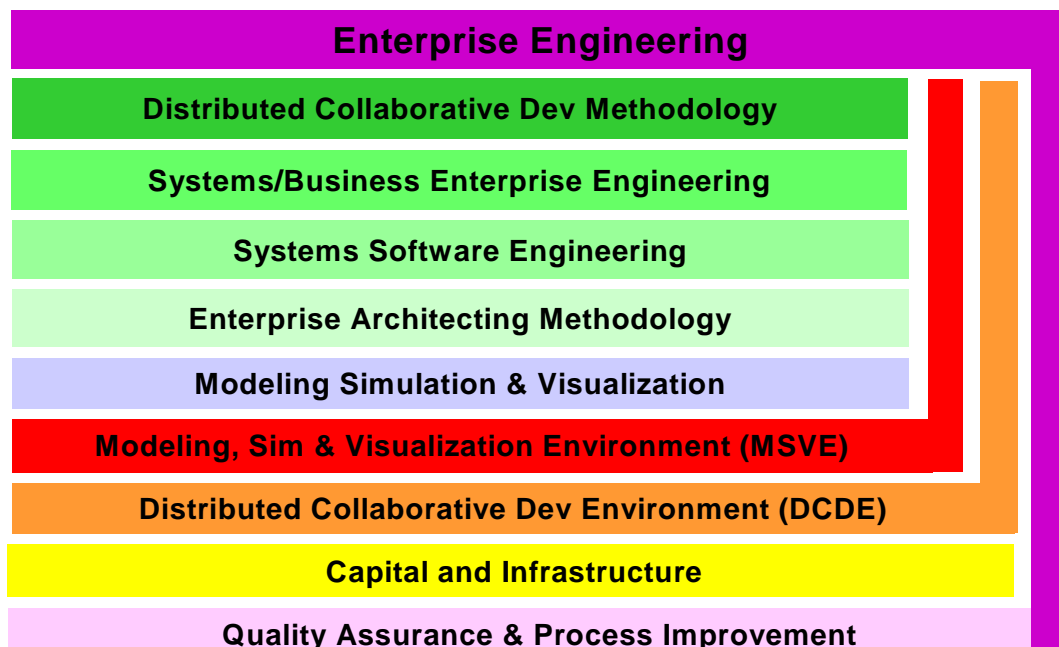

Figure 3 – Capabilities of integrated enterprise environments

Negative trends in the global environment affecting the state of systems engineering practice range from a lack of appreciation for the value of systems engineering to an inappropriate perception of systems engineering as a “silver bullet.” At this time, there is no agreed set of unified principles and models to support systems engineering use over a wide range of domains. Nor is there a set of consistent terminology and definitions. These two deficiencies impede the adoption of systems engineering and create problems, such as in serving the needs of smaller businesses. They also contribute to a lack of consistency in the education of systems engineers. In addition, systems engineering practices do not consistently address and integrate factors other than hardware and software in a balanced fashion. Some practices fail to recognize the roles of people in systems, as well as the

¹ (<http://www.sei.cmu.edu/cmmi/general/>),

reality that facilities, procedures, processes and even naturally occurring entities may be significant parts of systems.

The core challenge for industry in the 21st century involves identifying and delivering value to every stakeholder. This challenge is exacerbated by the geographic and philosophical distances that separate stakeholders from each other despite their need to collaborate. Value can be define in terms of how various stakeholders derive worth, utility, benefit, or reward in exchange for their respective contributions to the enterprise.²

Systems and their Nature

The nature of systems can be observed through their attributes. Table 1 contains a set of attributes that were selected to compare systems observe trends in the way systems have changed over the past 25 years.

Table 1 – Attributes of systems used to observe changes over time

1.	Purpose, Scope & Capability – autonomy
2.	Complexity – including components & interfaces
3.	Systems of Systems
4.	Technology – used in the system itself
5.	Embedded Software and information processing
6.	Role of Humans – as part of the system
7.	Legacy System Composition

Purpose, Scope & Capability

Most engineered legacy systems were developed to meet a single, defined purpose. Seen generally, their scope encompasses a single enterprise, and they are deterministic with little autonomy. However, recently fielded systems, and systems under development indicate a trend toward more ambitious purposes across greater geography, and with increasing capability. “Super systems,” such as Air Traffic Control and Intelligent Transportation, require large teams and expansive infrastructures to produce and support. There is also a complementary trend towards increasingly smaller systems, even micro-systems, based on continually evolving technologies.

Complexity

Most system engineers acknowledge complexity as an attribute of systems³. However, there are different measures and interpretations of complexity. Some differentiate between internal and external complexity⁴. Others view complexity through the lens of system size⁵ or

² Murman et al., *Lean Enterprise Value*, Palgrave, 2002.

³ INCOSE, *Guide to the Systems Engineering Body of Knowledge (G2SEBoK)*, undated. This guide contains phrases such as “... varying complexity of the systems to which the discipline [of systems engineering] is applied.” and “For the design of complex systems, alternative designs reduce project risk.”

⁴ Blanchard & Fabrycky, *Systems Engineering and Analysis*, 4th Ed, Prentice Hall, 2006.

⁵ Ricardo Valerdi, *Academic COSYSMO User Manual*, 2006, MIT Lean Aerospace Initiative Consortium - Describes four drivers that determine the size of the system in terms of systems engineering: # of system requirements, # of system interfaces, # of algorithms, and # of operational scenarios.

in combination with other terms such as complex adaptive systems⁶.

For the purpose of comparing systems today and in the future, complexity can be considered as a measure of how well knowledge of a system's component parts explains the system's behavior and also by the number of mutually interacting and interwoven parts, entities or agents. Trends indicate that systems of all types are continuing to become more complex in their composition, capabilities, and interfaces.

There is a general trend towards creating solutions for increasingly complex problems. This trend is motivated by an overall increase in societal need for systems of ever-greater variety (scope, miniaturization, accuracy, acuity and autonomy), effectiveness, and economy. Yet, there is continuing evidence of significant project failures, often traceable to excessive complexity, poor architectural choices, ill-defined processes, the application of immature and/or non-validated practices, or the lack of experience and education of the team applying valid practices.

For these reasons, there is a growing recognition of the important role played by the system's architect as a vital component of systems engineering, especially in the concept development phase for complex ventures, such as interplanetary space missions, globally distributed networks, automotive drive-train systems, consumer imaging systems and the reengineering of corporations, to name a few.

Systems of Systems

Nature provides many examples of "systems of systems." Increasingly, systems engineers are recognizing that they also create systems of systems. These efforts arise from the trend towards aggregating otherwise independent systems to achieve an emergent behavior that is not evident in the individual systems. Such systems tend to be highly networked, or "net-centric." This requires system components to be adaptive, able to self-discover, and utilize other components and component interfaces. The systems engineering of systems of systems is influenced by the greatly increased number of stakeholders across the enterprise, as well as the complexity of the interfaces to be designed and managed. Large systems of systems require a coordinating body to evolve the system architecture, to produce 'federal rules' and to manage the constantly changing interfaces, both internal and external.

The development and integration of systems as "systems-of-systems" creates numerous interfaces (interaction effects) with other systems. The support structure for a given system must be properly integrated with the corresponding capabilities for other closely related systems, both nationally and internationally. Systems are also being developed and deployed worldwide, to a greater number of locations, in response to a wide variety of international needs, and the depth (degree) of support will vary from one operational site to the next. Past practices of establishing an extensive logistics and maintenance support capability at one or two fixed locations are no longer valid. This is all happening when available resources for system support (in general) are dwindling worldwide, and at a time when international competition is increasing.

Technology

Advances in technology enable systems with new capabilities – previously unattainable purposes – but may also enable systems engineers to develop systems that accomplish previously attainable purposes in new, more efficient ways. Therefore, the technology of a

⁶ Sarah Sheard, (2006), Complex Systems Sciences as a foundation for Systems Engineers, Proceedings from the Fourth Annual Conference on Systems Engineering Research (Los Angeles, CA; April, 2006).

system is a useful attribute to describe systems today and in the future⁷. Figure 4 illustrates the accelerating pace of technology innovations.

Technology trends noted today will affect future systems. These trends include:

- Increasing computation power and information storage
- Increased miniaturization, including nanotechnologies
- Increased use of biotechnology
- Increased connectivity and interoperability
- Integrated process technology within the system.

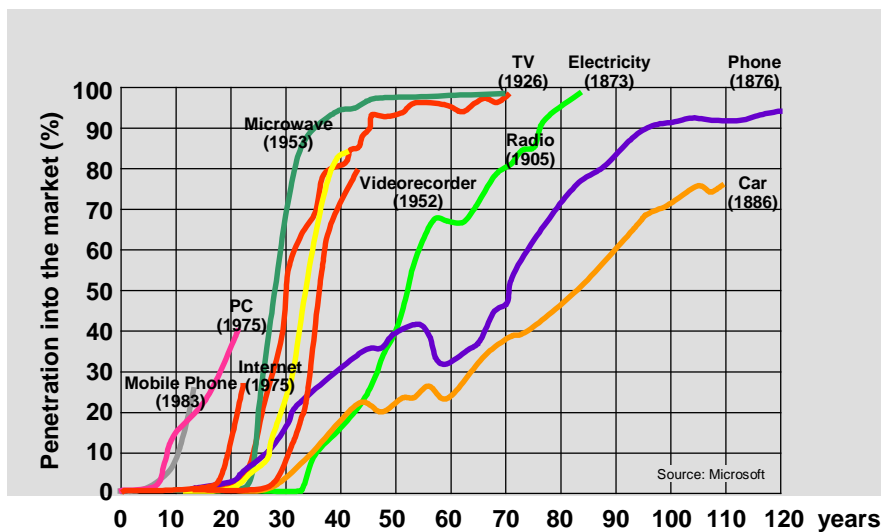

Figure 4 – Accelerating pace of technology innovation

Embedded Software and Information Processing

Mechanical control systems are being replaced by digital software-controlled systems. Even systems normally characterized as information technology systems have components that are increasingly decentralized and viewed as services provided to a larger system or systems. The primary trend in embedded software and information processing is that the relative proportion of software to hardware is increasing exponentially⁸.

The nature of the software inside systems today is primarily proprietary, belonging to a commercial firm or the developer. However, trends in software development and in acquisition indicate a willingness to adopt open source software. Open source strategies, where important intellectual property is deliberately made freely available to create a larger and more dynamic market (for example, JPEG image compression/decompression), produce a “win-win” situation that benefits both the creator of the intellectual property and its users.

Role of Humans in Systems

Human-based systems – such as organizational systems, have existed throughout modern history. For engineering, mechanical and information systems, however, humans have been seen primarily in the role of operators and maintainers.

⁷ Note: technology can also provide better tools for systems engineers to help develop and oversee the development of systems as described elsewhere in this paper.

⁸ Herbert Negele, 2006, Closing Keynote, 16th Annual INCOSE International Symposium, Orlando, FL.

Trends indicate two ways of treating humans as part of the system. First, as information technology and sensor technology improve, systems will exhibit greater autonomy, requiring less direct human direction or intervention. Conversely, as the purpose, scope, and complexity of systems increase, human decision making capabilities will remain within the scope of the overall system.

Legacy Systems

Old systems may be replaced when they wear out or because a new system provides significant additional capability. However, replacement costs are generally high, so systems are modified and updated beyond their expected life expectancy. Recent initiatives from industry and government for information systems include wrapping some systems to support information exchanges (e.g., Web Services) as well as adapting legacy systems to new missions. The growing recognition of legacy systems will demand a greater pool of experience and approaches for maintaining legacy systems for longevity as well as improved performance.

Systems Engineering Processes

Process descriptions are evolving, and best practices are being codified, largely in conjunction with efforts to create standards and models of best practice and maturity. Many companies and organizations that attempt to define their internal processes according to these standards and models are doing so for the first time. Furthermore, current systems engineering processes descriptions require tailoring from project to project and there are no stable versions that apply across multi-party teams, particularly when the parties are different corporations.

The maturity and formalism of systems engineering processes has also brought some unwanted consequences. It has created a perception of burdensome, heavyweight efforts, leading to unjustified cost and time overheads. The result is that the application of systems engineering in small and medium-scale enterprises, where the majority of engineering is conducted, remains weak. Adoption is further impeded by a lack of lean/agile process sets and life cycle concepts. There are trends toward multi-disciplinary enterprise processes across the organization, driven by an increased need for multiple views of the systems engineering processes that extend into socio-technical, economic and political perspectives.

It has never been more important to have coherent systems engineering processes that can be applied across multi-party teams. Transactions within and between organizations rely on common agreement upon the processes to be followed, particularly for medium and large-scale organizations, and to provide coherence within supply chain relationships. Global collaborations and complex structures of subcontracts and suppliers make common understanding of process even more important. Industry is lacking a set of lean/agile principles that could firstly, remove tasks that do not provide added-value and secondly, provide adaptability across a diversity of organizational structures.

Creating systems of systems is stretching the ability of industry to engineer systems using current processes and methods. It is increasingly difficult to engineer systems using sequential, requirements-predicated models of practice. The challenge is learning to deal with accelerating changes in both user needs and external environments. Such realities will continue to force change in the engineering paradigm to one that adopts biological metaphors and complex systems theory. Approaches such as the European Network of

Living Labs⁹ encourage and support the involvement of all stakeholders and especially end-users in the co-creation process. Members of the network use the internet and other virtual media to share information about how new systems affect them.

Models and Model-based Systems Engineering

Model-based systems engineering (MBSE) is the formalized application of modeling to support system requirements, design, analysis, verification and validation activities beginning in the conceptual design phase and continuing throughout development and later life cycle phases. MBSE is part of a long-term trend toward model-centric approaches adopted by other engineering disciplines, including mechanical, electrical and software. In particular, MBSE is expected to replace the document-centric approach that has been practiced by systems engineers in the past and to influence the future practice of systems engineering by being fully integrated into the definition of systems engineering processes, as illustrated in Figure 5.

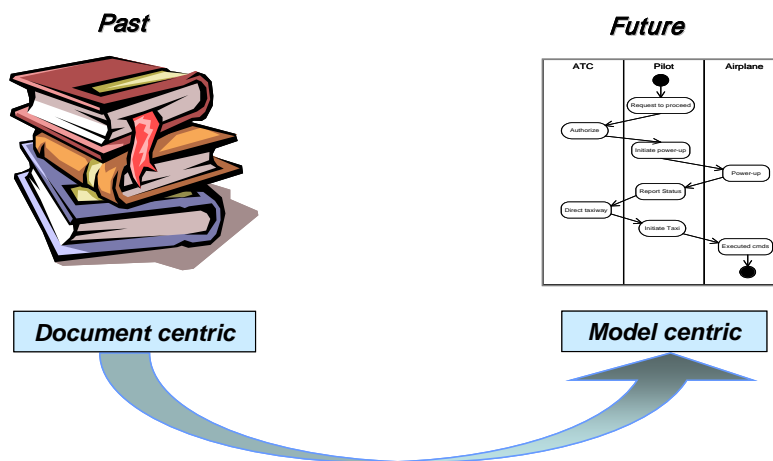

Figure 5 – Transition from document-centric to model-centric systems engineering

Currently, the MBSE process and methods are generally practiced in an ad hoc manner and not integrated into the overall systems engineering processes. The MBSE tools support various modeling techniques, such as functional analysis and object-oriented analysis, but only partially support model and data interchange. When a suite of tools is involved, different training is required for each tool and each method, pending the acceptance of standards to enable MBSE. The resulting lack of tool interoperability has been a significant inhibitor to widespread deployment of MBSE. The absence of convergent MBSE standards to date is a further impediment to adoption, imposing unique training requirements for each tool and method.

Systems modeling standards are beginning to emerge that should have a significant impact on the application and use of MBSE. Explicit examples are the development of the Object Management Group (OMG) Systems Modeling Language (SysML™)¹⁰ and the ISO 10303-233 Application Protocol: Systems Engineering and Design (AP233). SysML™ is a general purpose graphical modeling language for specifying, designing, analyzing and verifying complex systems that was adopted by the OMG in 2006 and is beginning to be implemented in MBSE support tools. SysML™ is part of a broader family of standards being developed by

⁹ (<http://www.cdt.ltu.se/projectweb/4421cddc626cb/Main.html>)

¹⁰ (<http://www.omg.sysml.org>), (<http://www.omg.org>)

the Object Management Group that includes the XML Metadata Interchange (XMI). This standard provides a means to interchange modeling information between tools using the XML format. AP233 is a neutral data interchange standard to support exchange of systems engineering data amongst tools that complements XMI. It is being developed in a modular fashion to address the breadth of systems engineering data. Selected AP233¹¹ modules are entering the early stage of the ISO balloting process.

Several architecture frameworks have been introduced to support enterprise and systems of systems modeling. The Zachmann framework, developed in the 1980's, and the Federal Enterprise Architecture Framework (FEAF) are used in selected industries. Military frameworks include the US Department of Defense Architecture Framework (DODAF),¹² the UK Ministry of Defence Architecture Framework (MODAF) and the NATO Architecture Framework (NAF).

Leaders in the adoption of MBSE are already taking advantage of the availability of advanced automated methods and techniques. For example, in lieu of a textual statement of requirements, some acquirers develop models defining the performance, environment, constraints, measures of effectiveness, quality, stakeholders and their roles, and specific scenarios, in which their envisioned system will operate—all defined around a “black box” system. Suppliers respond with their own model that replaces the black box with a detailed white box representation of their system concept, including design and operational concepts and risk mitigation approaches. Acquirers are then be able to select the bidder whose model (and proposal) best satisfies their requirements.

Other emerging standards are beginning to gain acceptance and may influence the evolution of MBSE. These include the Business Process Modeling Notation (BPMN) for modeling business processes, and standards that support the OMG model-driven architecture (MDA) approach. The High Level Architecture (HLA) standard has been available for several years to support distributed simulation, and other standards are now being developed in this area.

Systems Engineering Education

At the time of writing, the number of masters' programs in systems engineering is growing in comparison to the number of undergraduate and doctoral programs. For example, within the USA there are 11 Bachelor of Science, 27 Master of Science, and 10 PhD programs that include the words “systems engineering” in the title.¹³ The situation in other countries varies as systems engineering courses may often be taught within other academic disciplines.

There is little evidence of students receiving exposure to systems thinking principles before college. However, there is a trend to introduce an infusion of systems thinking and limited exposure to systems engineering in undergraduate engineering curricula for classroom projects. Classical undergraduate engineering programs in a disciplinary specialty are evolving to more systems-centered disciplinary programs, often teaching approaches needed to engineer a complete system.

There have been attempts to apply systems engineering techniques to socio-technical issues by introducing students to real-world experiences, such as national security, natural disaster mitigation, etc. Interactions between young students and universities and corporations prepare them to work in teams and to think about the entire problem space. Both students

¹¹ (<http://www.ap233.com>)

¹² (<https://dars1.army.mil/IER/index.jsp>)

¹³ Wolter Fabrycky, 2007, *INCOSE INSIGHT, Special Academic Issue, July*.

and working professionals will achieve educational outcomes (ability to work in teams, solve problems, and think systematically with accompanying attitudes, values, work ethic). However, most traditional engineering programs still do not have a systems engineering focus. As a result, many companies hire engineers with a narrow skill set and offer on-the-job training in systems engineering. In the US in particular, this has given rise to systems engineering certification programs. A competent Systems Engineer has depth in systems engineering and educational breadth in one or more technical areas, in addition to project management, as illustrated in Figure 6.

At the undergraduate level, there appears to be no standard definition for a systems engineering curriculum. Some systems engineering curricula are focused on Operations Research, others on Systems Analysis, and yet other approaches are combined with Industrial Engineering. There is still considerable divergence concerning whether systems engineering is best taught from a domain-centric (e.g., military/aerospace, transportation, energy, automotive, etc.) viewpoint or a generic systems engineering viewpoint.

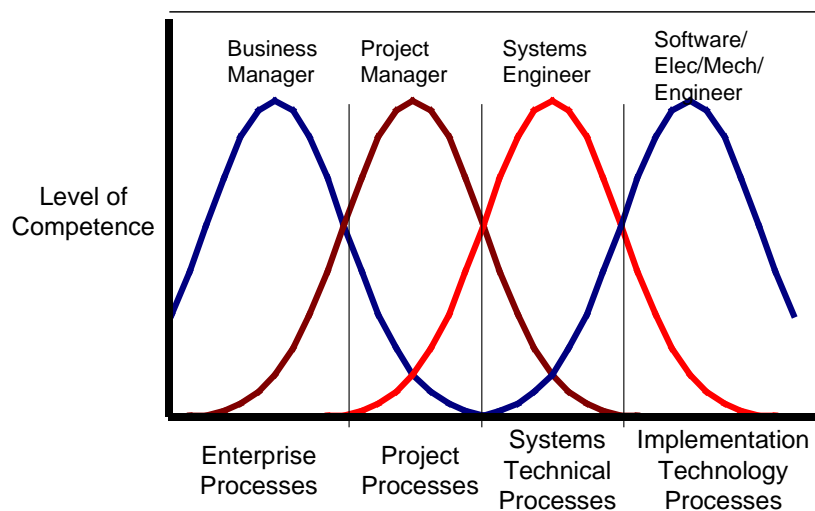

Figure 6 – Engineering Competence Profiles¹⁴

At the graduate level, there is a continuation of this thrust as well as the evolution of innovative interdisciplinary and transdisciplinary programs. For example, the University of Pennsylvania has offered a joint MSE/MBA degree for several years combining curriculum in Systems Engineering (Moore and Towne Schools) with Business Administration (Wharton Business School). Nevertheless, there remains little cross training across programs and most programs still lack core courses on systems thinking. Some graduate programs struggle with filling open academic positions, and others struggle with achieving a correct academic balance between core academic faculty and “retired practitioners.” There is a growing trend to offer systems engineering courses taught by a mix of academic systems engineering educators and experienced practitioners.

The students learning systems engineering over the next two decades will be practicing their profession well into the 2040’s, 2050’s and probably 2060’s. The pace of change continues to accelerate, as does the complexity of the systems. This presents many serious, but exciting, challenges to systems engineering education, including:

¹⁴ Stuart Arnold, 1996, “Systems Engineering: From Process towards Profession”, Proceedings of INCOSE International Symposium, Boston.

- Anticipating future trends (as in this Systems Engineering Vision) and preparing students to deal with them;
- Capitalizing on information technology to enable the delivery of just-in-time and web-based education;
- Monitoring current principles and practices and separating timeless principles from outdated practices;
- Participating in leading-edge systems engineering research and practice and incorporating the results into the curriculum;
- Packaging smaller-scale educational experiences in ways that apply to large-scale projects;
- Helping students learn how to learn, through state-of-the-art analyses, future-oriented educational games and exercises, and participation in research; and
- Offering lifelong learning opportunities for systems engineers who must update their skills to keep pace with the evolution of best practices, and individuals entering the field from outside disciplines, who need further education to make the transition successfully.

Drivers and Inhibitors

Table 2 contains a sampling of observed drivers and inhibitors, categorized according to each of the five focus areas, which have significant potential to influence the state of practice of systems engineering – see the framework in Figure 1.

Table 2 – Drivers and inhibitors influencing the practice of systems engineering

Area	Drivers	Inhibitors
Global Environment	<ul style="list-style-type: none"> • Ability to create, produce and operate on a global basis, supported by rapid and extensive transportation of people and goods, plus high-bandwidth, globally integrated communications capability • Increasing collaboration among professional groups and other stakeholders, worldwide 	<ul style="list-style-type: none"> • Lack of mature standards and their uniform adoption • Increased global tensions; local customs and practices and, decreasingly, language • Heritage of systems engineering impacts its perceived application to social and non-traditional systems, and small to medium enterprises
Nature of systems	<ul style="list-style-type: none"> • Nonlinearly increasing ability to incorporate a greater capability for a given cost; to augment the embedded intelligence in systems and to provide systems with global dispersion • Emerging basic conceptual and technological areas with systems applications, such as chaos theory, nano-technology and genetic engineering 	<ul style="list-style-type: none"> • Human limits in comprehension and control of man-made systems • Immature view of the roles of people in (increasingly complex) systems, natural entities, processes and procedures, and facilities • Lag in manufacturing and sustainment capabilities • Slow grasp of the significance of new technologies and concepts
SE Processes	<ul style="list-style-type: none"> • Evolution of standards that give a consistent view of process sets that embrace all systems engineering functions on a life cycle basis • Emerging understanding of software engineering and systems engineering synergies 	<ul style="list-style-type: none"> • Lack of tools that enable use of existing standards • Excessively complex process sets and burdensome formalism creates a barrier to acceptance of systems engineering practices, especially in small and medium enterprises
MBSE	<ul style="list-style-type: none"> • Emergence and maturation of modeling languages and information standards • Continuing evolution of information technology as an enabler of modeling techniques 	<ul style="list-style-type: none"> • Inherent difficulty integrating models across organizational, lifecycle and other boundaries • Limitation of model /data exchange capabilities within the modeling tools • Limited MBSE skills
SE Education	<ul style="list-style-type: none"> • Recognition of need to inculcate systems thinking at earlier stages in individual educational experiences and with a broader context • Distance education putting the classroom in the home • Transition to transdisciplinarity in engineering education 	<ul style="list-style-type: none"> • Lack of an accepted set of theory and principles • Lack of an overarching vision or guiding framework for research • Lagging posture of curricula, exacerbated by funding shrinkage • Challenge of educating current employers in new concepts

Systems Engineering Vision 2020

The current state of systems engineering practice is evolving under the influence of the respective drivers and inhibitors called out in Table 2. Through a series of workshops, acknowledged at the end of this document, experts in systems engineering and related fields were brought together to hypothesize about the future of systems engineering, beyond the next decade. These results have been compiled and are presented here using the same five focus areas.

In a best case scenario, the experts anticipate that systems thinking and systems engineering will guide the way people think about solving problems in the next decade and systems engineering will become an established international “inter-disciplinary connector” or “meta-discipline.” Increased diversity within the stakeholder population creates the need for shared sense making through shared mental models; a need that systems engineering will satisfy. In the future systems engineering will be used to address the significant social, economic, environmental and planning issues of the day.

Global Systems Engineering Environment

By 2020, corporate and societal leaders will value systems engineering principles and those practicing them. Systems engineering will be seen as especially important for systems developed by multi-national teams. Systems engineering principles and processes will be the lingua franca for these teams, respecting cultural differences and facilitating effective communications. There will be more frequent and more effective collaboration among societies whose members practice systems engineering.

The solution-building environment of the future will feature interoperability among systems engineering practices. This will be enabled by collaborative tools and virtual collaborative environments that feature sophisticated capabilities combined with simplicity in the user interface. These tools will span a broader range of applications and support people-centric interfaces that provide an environment that addresses structural, social, technical, and cultural differences in order to compress or bridge collaboration distance between all involved stakeholders. Additional systems engineering capabilities will be created to support the adaptation of system engineering methodology to the agile and robust operations of extended enterprises and businesses of all sizes. This will include:

- Advanced systems theory application
- Increased use of analytical methods and tools
- Advances in engineering education with an emphasis on interdisciplinary integration
- Improved use/integration of engineering specialties
- Improved understanding of psychology, languages and culture
- Improved shared understanding of systems engineering concepts among all stakeholders

Stovepipes between disciplines will begin to blur as the benefits – diversity of ideas, lower organizational costs and greater development efficiency – of interdisciplinary integration are realized. Stakeholders will take the time to identify the characteristics (capability, culture, communication and decision making style, appetite for risk, ethics, etc.) of their global business partners. Business strategies will continue to exploit the benefits of distributed worldwide production capabilities with the associated sharing of resources and specializations for increased efficiency. Expansion of free trade regions will ease the flow of capital resources and open new global markets. Changing demographics in population (e.g., a longer lifespan, more open migration policies) will influence investments, the desirable

characteristics and capabilities of products and systems, as well as the composition of the global workforce itself.

Ongoing efforts within the ISO¹⁵, IEEE¹⁶ and EIA¹⁷ will continue to improve the usability of standards. Figure 7 illustrates the early stages of the evolution toward a unifying systems engineering standard. Such a standard will provide the foundation for systems engineering integration and domain-specific implementation guidance that spans hardware, software, humans, facilities, processes, procedures and naturally occurring entities.

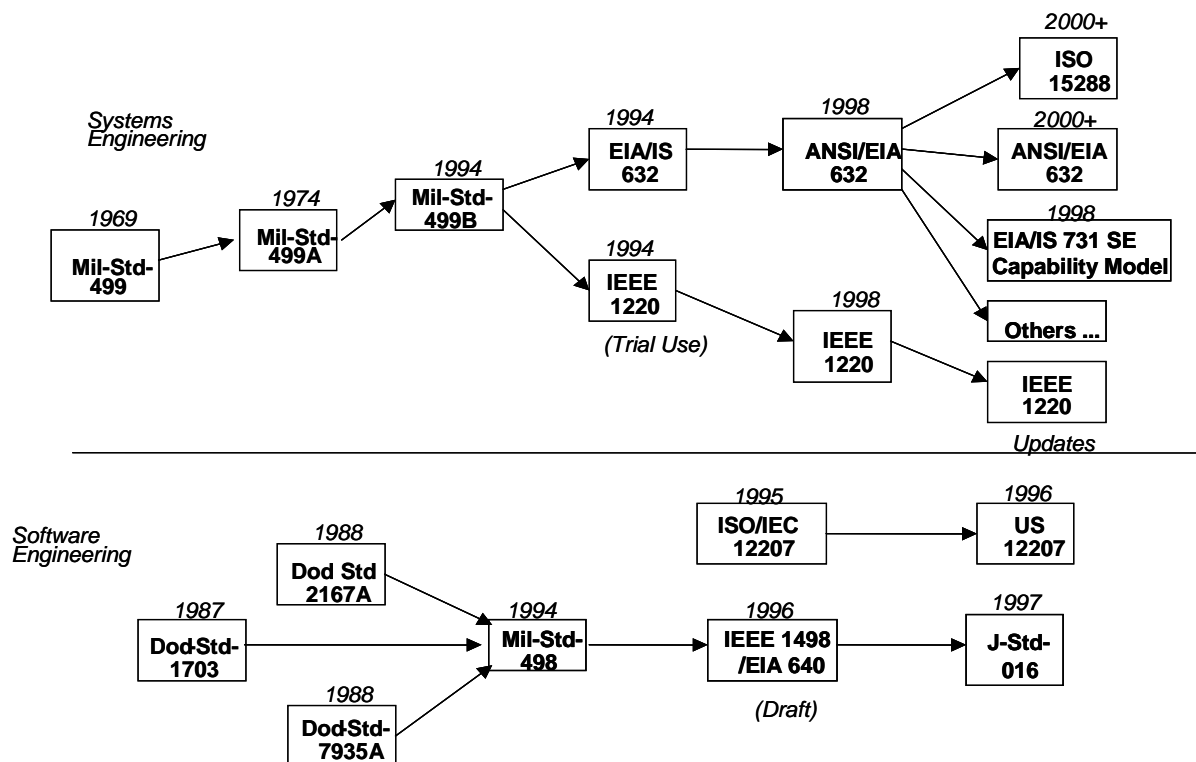

Figure 7 – Harmonization of Systems and Software Engineering Standards

Future standards will result in increased harmonization of engineering, project management and business processes. A better understanding of systems engineering processes will also emerge. It is expected that harmonization will result in a set of system, software and project management process standards that are aligned to ensure compatible usage.

Systems and their Nature

By 2020, systems will exhibit extensive interconnectedness. In geographical terms, local systems are giving way to regional systems. Systems engineers will continue to be challenged by the ability of new and legacy systems to join the encompassing system of systems. Issues surrounding legacy systems will increasingly influence system acquisition, design and upgrades. Systems will be designed for continuous adaptation, which will stimulate greater use of off-the-shelf components. Systems of the future will continue to exhibit the characteristics itemized in Table 1.

¹⁵ International Organization for Standardization (www.iso.ch)

¹⁶ Institute of Electrical and Electronics Engineers (standards.ieee.org)

¹⁷ Electronic Industries Alliance (www.eia.org)

The term "system architecture" will connote more than the technical architecture of the system. Architecture will envelope markets, customers, technology insertion, product development and deployment, and the needs of the enterprise into an integrated framework. With respect to architectural design, there will be greater clarity of architectural approaches, potentially based on a set of emerging systems engineering pattern languages and pattern structures. Additionally, the development, maturing, and continual evolution of languages (such as SysML™), tools and methods will contribute to the clarity and automation of these approaches.

Products and systems will include virtual devices with multiple sensory inputs. The integration of genetic engineering, micro-/nanotechnologies, biotechnology, and neurotechnologies will permit human/system interfaces to become highly sophisticated and complex. Artificial intelligence, virtual reality, adaptive systems, sensors for condition monitoring, robotics, and other technologies, will enable dramatic new capabilities, resulting in a broad range of new products. Embedded intelligence will allow further automation of complex products and processes. Software and hardware will become increasingly intelligent and adaptable, enabled by faster/better computer technologies and interfaces. An important challenge will emerge; learning, from a sound research basis, how to allow humans to complement system intelligence with human intelligence, rather than allocating intelligent functions to the machine and eroding the roles that humans are so uniquely able to fill.

Systems Engineering Processes

The systems engineering processes in 2020 will be robust enough to allow continuous technology insertion in order to accommodate the rapid acceleration of technological change. This will enable future systems to take advantage of emerging technologies by effectively integrating these technologies with legacy systems and with complementary technological advances.

Engineering and acquisition processes will evolve to fully support concurrently engineered systems. The success criteria will likely include the ability of a system to interoperate with other evolving systems, or its resilience in accommodating new technology or interfaces.

Process evolution will focus on keeping only those processes that produce value. Process agility and adaptability will be facilitated by advancements in tools for intelligent engineering environments. As processes across the project and enterprise become more mature and integrated, the use of workflow management tools will become more widespread. This will assist planning and control activities.

Improved decision-making support will include realistic cost estimation for both product development and the total system lifecycle. Methods and tools for trade-off management including the capability of modelling the long-term effects of decisions will emerge. The systems engineering processes of the future will enable the development of an effective and efficient "logistics and maintenance support infrastructure." Elements of the support infrastructure will be as reliable as (if not greater than) the items being supported. Thus, in the design and development of the support infrastructure, addressing a number of important characteristics (e.g., resilience, reliability, maintainability, supportability, economic feasibility, etc.) will become an inherent part of the systems engineering processes.

With this in mind, the state of the best practice in systems engineering in 2020 will be characterized in the following manner:

- Continuous process improvement will be a widespread practice. The emphasis will be on this continuous improvement and not on a transient achievement of a specific level of process maturity.
- There will be an increased coordination and harmonization of process standards, including other disciplines and business processes. This will not be trivial, but will lead to a greater strength and utilization of systems engineering by minimizing confusion and conflict.
- Systems engineering processes will be aligned with stakeholder values, recognizing that stakeholders seek value and that only those processes that enhance value will be supported in the long term.
- Projects and programs will regularly use process simulation and sensitivity analysis to reduce risk.
- There will exist a robust strategy for integrating cognitive-human-socio-technical concepts into a comprehensive systems engineering processes instantiation to include:
 - Intelligent decision support systems
 - Process evaluation and feedback with real-time analysis effectiveness and efficiency
 - Knowledge management
 - Automated trend analysis to identify risks and opportunities.

Model-Based Systems Engineering

The projected state of MBSE practice in 2020 will extend MBSE to modeling domains beyond engineering models to support complex predictive and effects-based modeling. This will include the integration of engineering models with scientific and phenomenology models, social, economic, and political models and human behavioral models. The key characteristics of MBSE in 2020 include:

- Domain-specific modeling languages and visualization that enable the systems engineer to focus on modeling of the user domain
- Modeling standards based on a firm mathematical foundation that support high fidelity simulation and real-world representations
- Extensive reuse of model libraries, taxonomies and design patterns
- Standards that support integration and management across a distributed model repository
- Highly reliable and secure data exchange via published interfaces.

Domain-specific modeling languages built on the general purpose systems modeling language will increase the abstraction level to represent the user domain. Validated and specialized model libraries for specific domains will be established that can be reused across organizations and evolved over time. A system engineer familiar with the domain will be able to rapidly search the distributed model repository and evaluate a broad trade space of solutions based on an understanding of the user requirements and measures of effectiveness. Thus, the systems engineer will readily perform what-if analysis to assess the requirements, design, and technology impacts, and optimize the solution, using multi-dimensional visualization capabilities.

The conceptual depiction in Figure 8 indicates a desired goal and direction toward advancing capabilities for MBSE. The integrated capabilities shown will dramatically increase the

application of MBSE to support marketing research, decision analysis, integration with biological system models, environmental impact analysis and the design of social systems in support of urban planning and government social programs, to name a few.

Collaborative environments will be set up quickly for new project teams and extended across global government, industry and academic teams. Management of product data throughout the lifecycle will provide improved logistics and Operations and Maintenance phase support, since design data is retained in standards-based repositories. Virtual development environments will minimize the need for physical prototypes and will accelerate new product development while providing realistic verification against customer driven requirements.

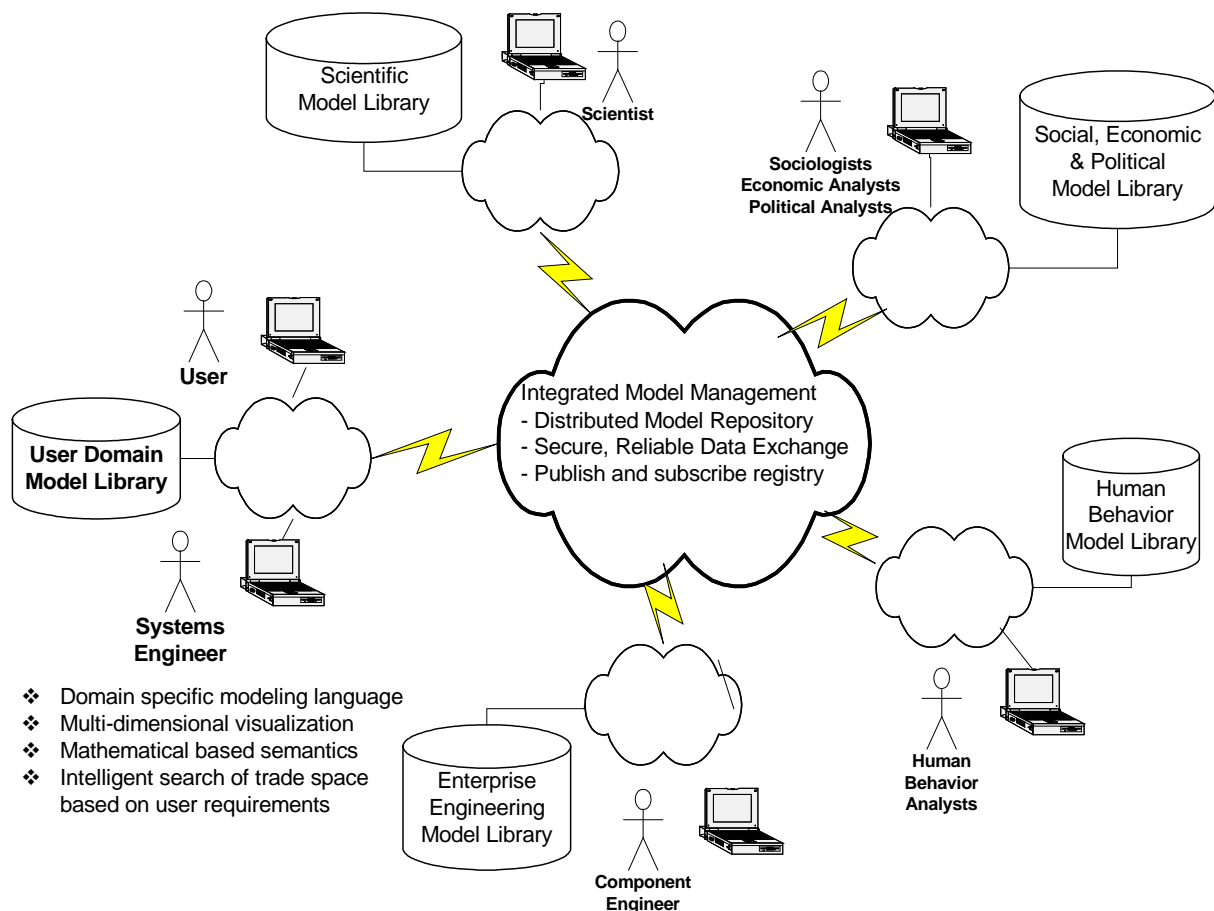

Figure 8 – Cross-domain model integration

System development times will be substantially reduced relative to current practice, while improving overall system quality and availability. This will be accomplished by a combination of failure-mode avoidance and knowledge-based engineering. The application of increased computer power will enable rapid system design with models in virtual development environments, greatly reducing the need for physical prototypes.

The breadth of applied models will not be confined to the traditional extent of dealing with the immediate system interfaces. Relationships will emerge between individual system models that are built to analyze systems across life cycles spanning decades and the social and economic models that estimate the impact of cumulative decisions on the economy and our environment. “Intelligent systems” will add significant effort to up-front systems engineering with the benefit of enabling planned change at an industry, domain, or societal level. System

models and simulations will explore the impacts to our environment, society, and the stakeholder organizations in ways that are ignored today and discovered by analysis of impacts after systems become operational.

A complete discussion of the MBSE vision must also be accompanied by realistic concerns about inhibitors to its progress such as those described in Table 2. Difficult technical and cultural challenges remain to be overcome in order to realize the many facets and benefits of the envisioned MBSE evolution. Meaningful progress will require both market forces and motivated visionaries inclined to take some risks in pushing the envelope to demonstrate value, exploiting opportunities and setting an example for others to follow.

Systems Engineering Education

The systems engineer of 2020 will develop expertise in the user domain and be able to address the social, economic and political impact of solutions. The education and training for systems engineers will focus on developing expertise in specific domains of interest, with an educational foundation in non-engineering disciplines such as sociology, psychology and economics. As a result, the systems engineer will have the requisite competence to work in a highly distributed and multi-disciplinary environment with rapid access to a broad range of resources, and an understanding of human behavior and human-system interaction.

The vision for systems engineering education can be grouped into four primary areas:

- Insertion of systems engineering principles into an expanded curriculum
- Influence of systems engineering techniques in a technical society
- Innovative approaches toward systems engineering education delivery
- Increased collaboration between educational institutions, societies interested in systems engineering, and persons with interdisciplinary interests

Insertion of systems engineering principles into an expanded curriculum

A core of system engineering courses will be used to expand the traditional engineering disciplines (e.g. electrical engineering, mechanical engineering, chemical engineering, and nuclear engineering) as well as non-engineering disciplines (e.g. psychology, agriculture, environmental science, information technology, and healthcare). In this manner, education in systems thinking and systems engineering will permeate both undergraduate and graduate programs.

Collaborations will be established between the Schools of Engineering, the Schools of Management, the Schools of Medicine, and the Schools of Law. There is likely to be fluidity of curricula and a resulting fluidity of professors between these professional schools. The expectation is that systems engineering will remain an area of study of its own; however, there is a potential for the study of systems engineering to become interwoven in the academic fabric.

Influence of systems engineering principles in a technical society

By 2020, it will be acknowledged that the systems engineering curriculum is an appropriate academic foundation from which to address multi-disciplinary problem solving, such as the implications of technology on the environment and society, drug abuse prevention, national security, crime prevention, urban expansion, infrastructure development, etc. Systems engineering educators and researchers will participate in the application of systems thinking to governmental and large scale societal problem solving.

Innovative approaches toward systems engineering education delivery

In 2020, web-enabled information technologies will be commonplace. Widespread globalization of education programs, with no national boundaries, will be the norm.

Information “chunking” will be used extensively in education and training. This will affect systems engineering in two ways. First, systems engineering education itself will be “chunked” to enable just-in-time delivery to a variety of consumers. Second, information chunking, in which a basic unit of information is customized for presentation to specified audiences, will become a required systems engineering skill.

Use of technology (such as simulation, visualization, or gaming) will create major innovations for systems engineering education. Building on the computer gaming culture, the systems engineering community will benefit by creating interactive games that require systems thinking (e.g. model cities development, survival games involving multiple disciplines, economic decision-making). Faculties will encourage and support faculty members to keep pace with new knowledge and use of advanced technologies.

Increased collaboration between educational institutions, societies interested in systems engineering, and persons with interdisciplinary interests

New institutional forms and frameworks will evolve to achieve the aforementioned transdisciplinary cooperation in schools of education. These frameworks will involve humans, organizations, technologies and environments in a way that leads to knowledge integration, knowledge process integration, or transdisciplinarity as is best appropriate in specific circumstances for resolution of contemporary issues of large scale and scope. One appropriate definition of transdisciplinarity is that it is the transformation, restructuring and integration of knowledge from multiple perspectives to produce a new holistic perspective. Activities that comprise transdisciplinary efforts include: cooperation, appreciation, disaggregation or taking apart, aggregation or putting together, modification and transformation. Ultimately, this should lead to the ability for successful knowledge generalization.

Doctoral-level research will be divided between research focused on specific topics, and research focused on higher-level theory. Funding for research will derive from consortia and industry. There will be increased industry involvement in universities and the number of professors who have in-depth practitioner experience. Research conferences will encourage contributions from both academic and industry researchers – see figure 9.¹⁸



Figure 9 – Conference on Systems Engineering Research

¹⁸ (<http://www.incose-la.org/temporary/cser2008/>)



Since 2002, the University of Southern California has collaborated with Stevens Institute of Technology to conduct an annual research conference. The primary objective of this event is to provide practitioners and researchers in academia, industry, and government a common platform to present, discuss and influence Systems Engineering research with the intent to enhance Systems Engineering practice and education.

Implications for the Advancement of Systems Engineering

The projected state of systems engineering described by the foregoing material has significant implications for the systems engineering research agenda to the year 2020 and beyond. The following material provides a few (of many potential) areas for meaningful investigation.¹⁹

Systems and their Nature

As systems increase in purpose, scope and scale to span international boundaries, research is needed to understand the nature of these systems and methods for tackling the problems they propose to solve.

- *Apply systems engineering to large-scale global problems.* Research is needed to understand the best way to apply systems engineering to significant problems, such as sustainable development, global warming, potable water supplies, fuels, hunger, and international conflicts. There are few examples of projects in this area; two examples are the eco-industrial park in Kalundborg, Denmark and the Global Earth Observation System of Systems (GEOSS) program, an international consortium of 61 nations working together to establish a system of comprehensive, coordinated, and sustained Earth observation.
- *Identify best practices based on international experiences in systems engineering.* The systems engineering community needs a source of best practices and case studies from the international community that highlight successful methods and techniques. Compiling a set of these best practices could be a research topic itself: finding successful corporate models for international enterprises and identifying changes necessary in systems engineering processes, education and training for operating in such enterprises. Additional research should yield means to establish an “open source model” for the intellectual property surrounding the best practices from successful applications of systems engineering in the global environment.

Systems Engineering Processes

Two areas for process-oriented research and development have been identified. They are initiatives to develop and evolve a seamless, end-to-end *systems engineering processes support environment* and to develop and evolve *collaboration support capabilities* for pervasive high performance, geographically distributed teams.

- *A Vision 2020 process support environment* would have well-integrated but easily upgradeable or replaceable capabilities for system modeling, simulation, prototyping, specification, business case analysis, planning, monitoring, change management, integration and testing. This implies the need for further research in: process modularization and composition; process architectures, languages and meta-languages; integration of human factors, hardware, software, and specialized domain engineering processes, and: associated capabilities for monitoring progress vs. plans, monitoring the business case for the plans and adjusting the plans when external or internal circumstances are making them obsolete. For example, one could consider extending current earned value monitoring systems, which have nothing to do with business or mission value, to address more value-based progress metrics and monitoring capabilities.

¹⁹ Conference on Systems Engineering Research, April, 2006.

- *Collaboration support capabilities* for pervasive high performance, geographically distributed teams, would complement the integrated process support environment above by providing more empowerment for individual systems engineers and better collaboration support for performing team activities. Individual empowerment capabilities would include better visualization capabilities well beyond the usual two-dimensional, static, black and white artifacts currently used by systems engineers; better access, searching and mining of distributed databases and knowledge bases; knowledge-based tools for performing and integrating specialty engineering (safety, security, usability, performance, application-domain engineering), and; on-the-fly consistency, compatibility, and risk analysis of a systems engineer's artifacts as they are being developed. Team empowerment capabilities would include virtual synchronous and asynchronous collaboration support; integration of formally-organized databases and knowledge bases with ad-hoc blogs and wikis; better aids for teambuilding and trust building; distributed-team leadership and session-management support, and; more rapid and powerful support for creating and negotiating mutually satisfactory specifications, plans and solutions.

Beyond these examples, other high-impact systems engineering processes research initiatives include:

- Better defined theoretical foundations for systems engineering processes, including the theory and formalized semantics to support model based systems engineering;
- Systems engineering return-on-investment models that enable determining how much systems engineering is enough in various situations;
- Better integration of systems engineering, acquisition management, portfolio management, and enterprise management processes.

Model-Based Systems Engineering

Since the primary driver of increasing complexity in modern and future systems is the triad of computer science, software and communications technologies, it is fitting that we also look to these technologies to strengthen the ability of systems engineers to perform effective MBSE in order to manage this complexity. Simple and unguided extrapolation from current practices to MBSE is unlikely to provide the needed capabilities. Research to produce a set of foundational models and algorithms is proposed.

- *Multi-dimensional Mathematical Model Manager* – this feature employs graph theory—and its offshoot, constraint theory—to determine model consistency and permitted computations within models containing tens of thousands of variables. This capability and other formalisms should be applied to enhance the precision and mathematical foundation for modeling languages such as SysML™.
- *Evolutionary computation and generic algorithms* – able to search the vast trade space for satisfying designs.
- *Quantitative risk management* – computations based on decision theory, to converge on designs with the balance of cost, performance and risk preferred by the stakeholders
- *Value and preference model* – to translate the diverse requirements of the stakeholders as well as their risk assessments acceptance test standards that the model can verify.

Very little research to-date has been invested in the development of such models. Even partial success with respect to the above vectors promises substantial improvement in MBSE



and brings systems engineering closer to the long-term goal of a “Unified Theory of Systems Engineering.”

Acknowledgements

The INCOSE *Systems Engineering Vision 2020* document owes its existence to the efforts of many dedicated individuals over a period of several years. Initial plans for development of a technical vision were decided upon during the INCOSE Board of Directors (BOD) Summit Meeting, March 2002 at Fort Belvoir, Virginia. A group of INCOSE fellows and senior leadership participated in producing an initial strawman entitled “*INCOSE Technical Vision Executive Overview*” in July, 2002. This document addressed systems engineering origins and evolution, the global engineering environment, systems engineering management, processes and technologies, applied systems engineering and trends in engineering education and research.

Under the leadership of Donna Rhodes, then Director for Strategic Planning, the Executive Overview was extended and released as the “*INCOSE Perspectives on Engineering 21st Century Systems*” in August, 2003. The Perspectives paper was “offered as a catalyst for further development of a detailed vision to guide INCOSE and the worldwide systems community to pursue the most promising paths for advancing systems engineering research and practice.”

The efforts and insights of the Focus Teams from the 2004 Portland Systems Engineering Technical Vision Workshop provided the stimulation and motivation for the original Version of this document. The following authors wrote additional material based on the Portland workshop results and follow-on discussions:

- Ben Blanchard (Sustainment)
- Eric Honour (Technical Management)
- Jerry Lake (Systems Engineering Standards)
- Rashmi Jain (Systems Engineering Research)
- James Martin (Systems Architecture)
- Jim Schier (Systems Development)
- Andy Sage (Systems Engineering Education)
- Stan Weiss (Manufacturing)

There were more than 65 international participants in the Systems Engineering Vision 2020 Workshop conducted in Scottsdale, Arizona in 2006 from which evolved Version 2.0 of this document. Special mention is given in Table 3 to the focus group leaders, facilitators and recorders who prepared the workshop reports:

Table 3 - Systems Engineering Vision 2020 Focus Groups

Focus Group Theme	Leader	Facilitator	Recorder
Global Systems Engineering Environment	Bob Rassa	Hillary Silletto	Ray Hettwer
Future Systems	Elmer Hsu	David Walden	James Martin
Model-based Systems Engineering	Gerhard Lippner	Ralf Hartmann	Sandy Friedenthal
Process Evolution	Paul Nielsen	Stuart Arnold	Gary Roedler
Systems Engineering Education	Mary Good	Donna Rhodes	Bill Mackey

International review has influenced the final document. Contributions were received from the following organizations: the UK Institution of Engineering and Technology, the Systems Engineering Society of Australia, l'Association Francaise d'Ingenierie Systeme, the American



Institute of Aeronautics and Astronautics, the International Society of Logistics, and the European Society for Collaborative Engineering.

The many iterations of Version 2 benefited from the technical writing services of Dick Kitterman and Al Mink, and review provided by William D. Miller. Cecilia Haskins accepted the task of final editor to give the document a single voice.

Finally, the dedicated support of Heinz Stoewer (INCOSE President 2004-2005) and Paul Robitaille (INCOSE President 2006-2007) has ensured that the *Systems Engineering Vision 2020* project achieved an international systems engineering community consensus.

I most gratefully acknowledge all of the aforementioned efforts and apologize in advance for any omissions.

Respectfully,
Harry E. Crisp, II
INCOSE *Systems Engineering Vision 2020* Project Lead